



Offline Handwriting Recognition—Where we are and Where are we Going

Chris Tensmeyer | Research Scientist

#AdobeRemix
Jon Noorlander

Some Major Milestones

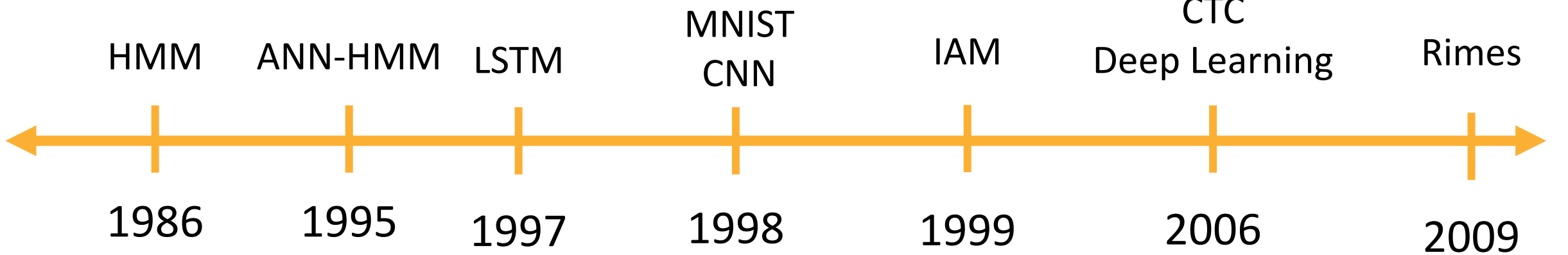
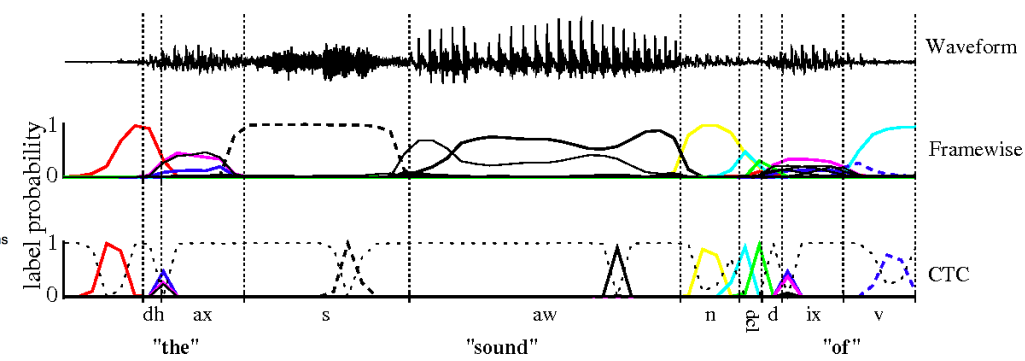
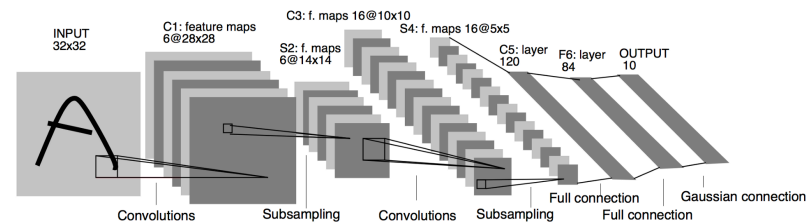
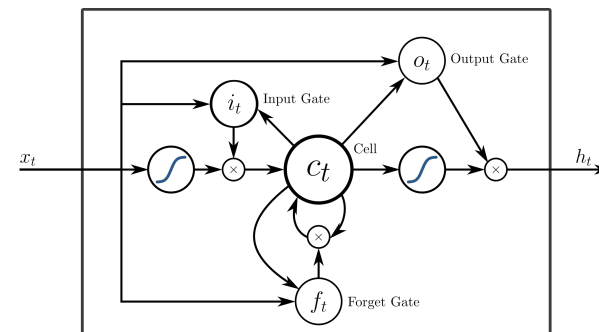
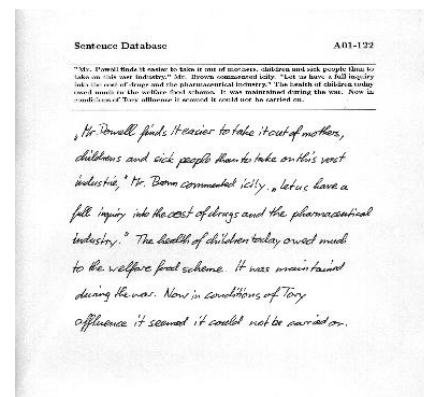
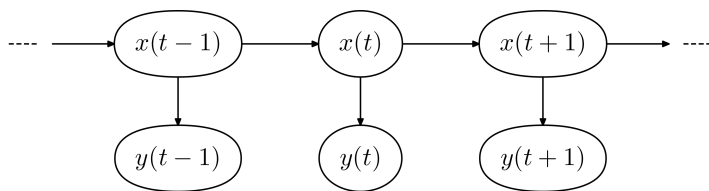

More Major Milestones

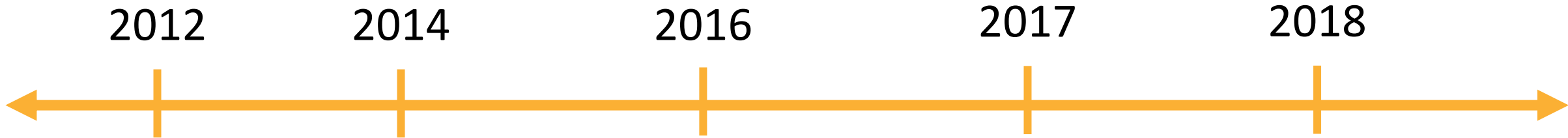
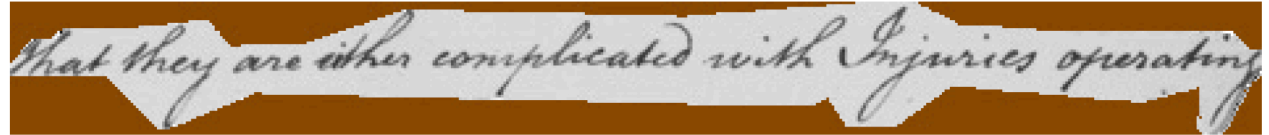

2012
AlexNet
MD-LSTM

2014
RNN-LM
Bentham

2016
CNN-RNN
Attention
PHOC-Net

2017
Full Page
Data Aug.

2018
Learned Dewarping
MD-CTC

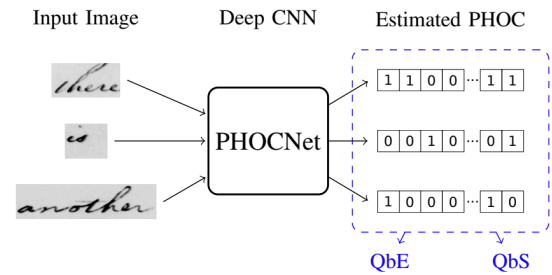
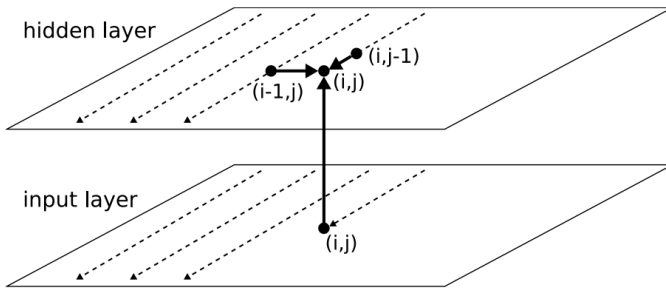
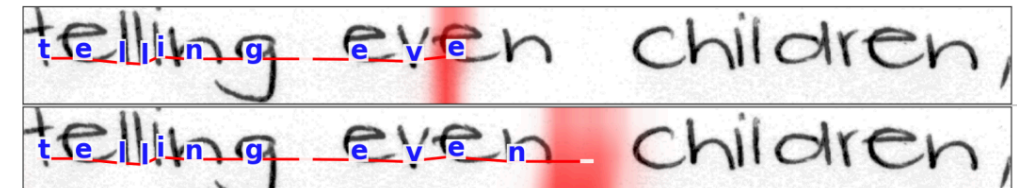
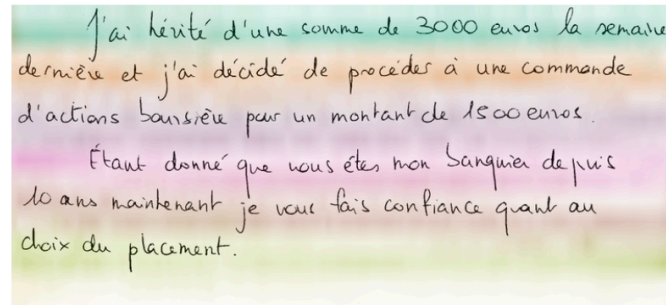
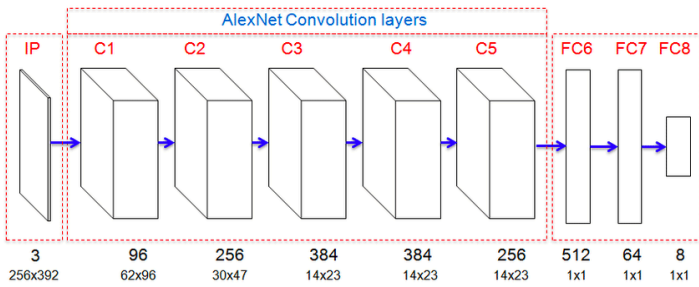

Observations

Granularity of Recognition

1913



2017

Character



Word



Line



Paragraph



Full Page

More Segmentation
Annotation



Less Segmentation
Annotation

Source of Technologies

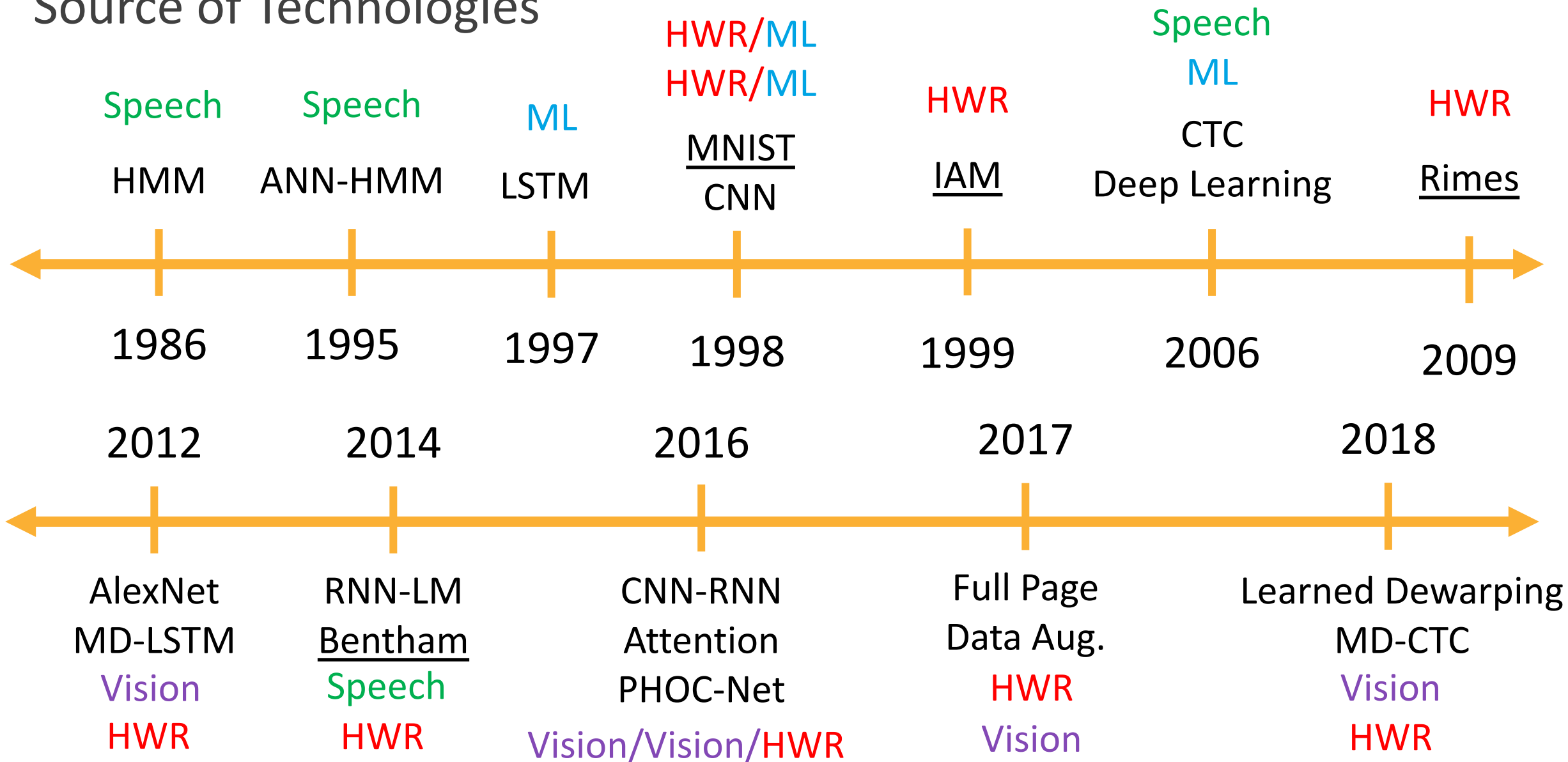

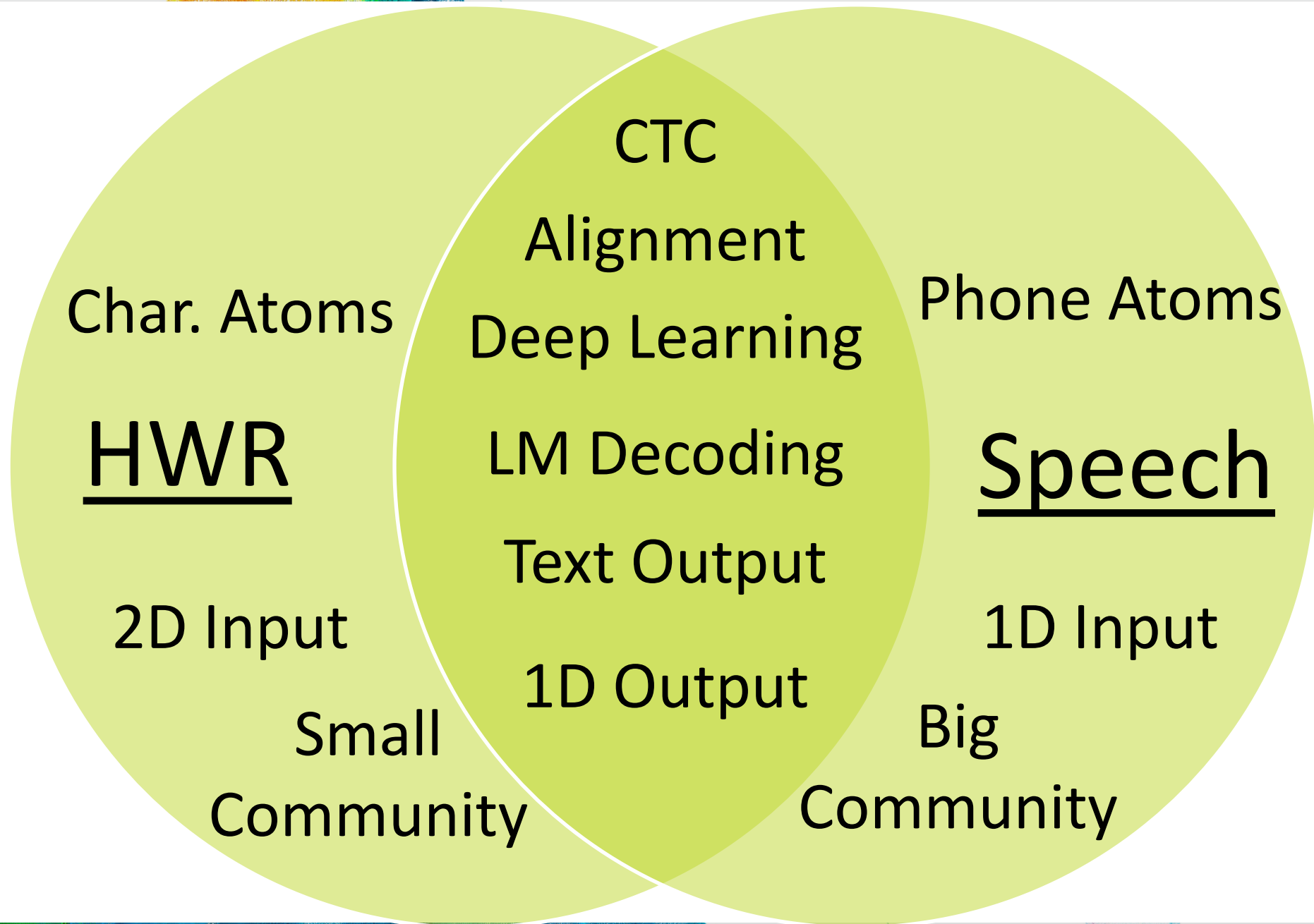

Future

Focus on *Unique* Aspects of HWR
Continue Borrowing for *Shared* Subtasks

Exploit Within-Page Similarity



Monolithic Model

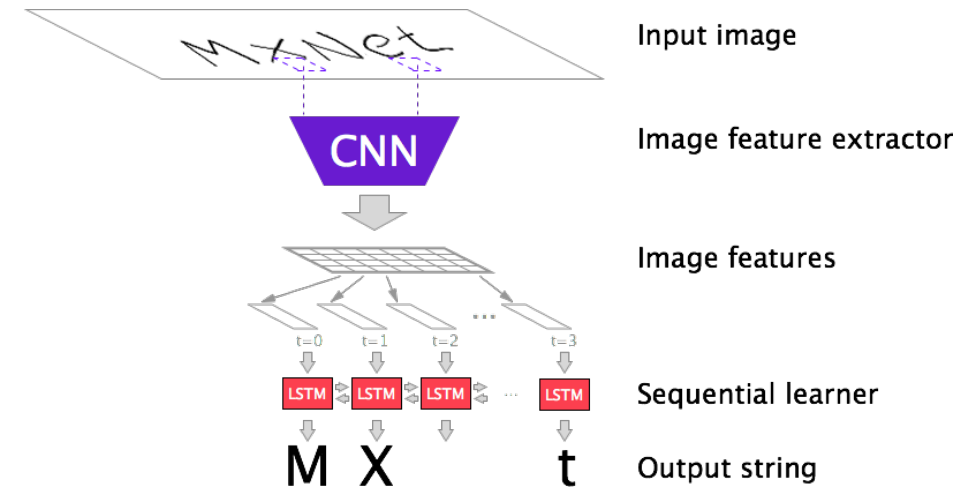

- Repeated Words Predicted Independently
- Model is general, not specific to this author's style.

Repeated Words have Similar Appearance

Align Transcriptions to Images



In Congress, July 4, 1776. The unanimous Declaration of the thirteen united States of America, When in the Course of human events, it becomes necessary for one people to dissolve the political bands which have connected them with another, and to assume among the powers of the earth, the separate and equal station to which the Laws of Nature and of Nature's God entitle them, a decent respect to the opinions of mankind requires that they should declare the causes which impel them to the separation. We hold these truths to be self-evident, that all men are created equal, that they are endowed by their Creator with certain unalienable Rights, that among these are Life, Liberty and the pursuit of Happiness.--That to secure these rights, Governments are instituted among Men, deriving their just powers from the consent of the governed, --That whenever any Form of Government becomes destructive of these ends, it is the Right of the People to alter or to abolish it ...

Exploit Available Data

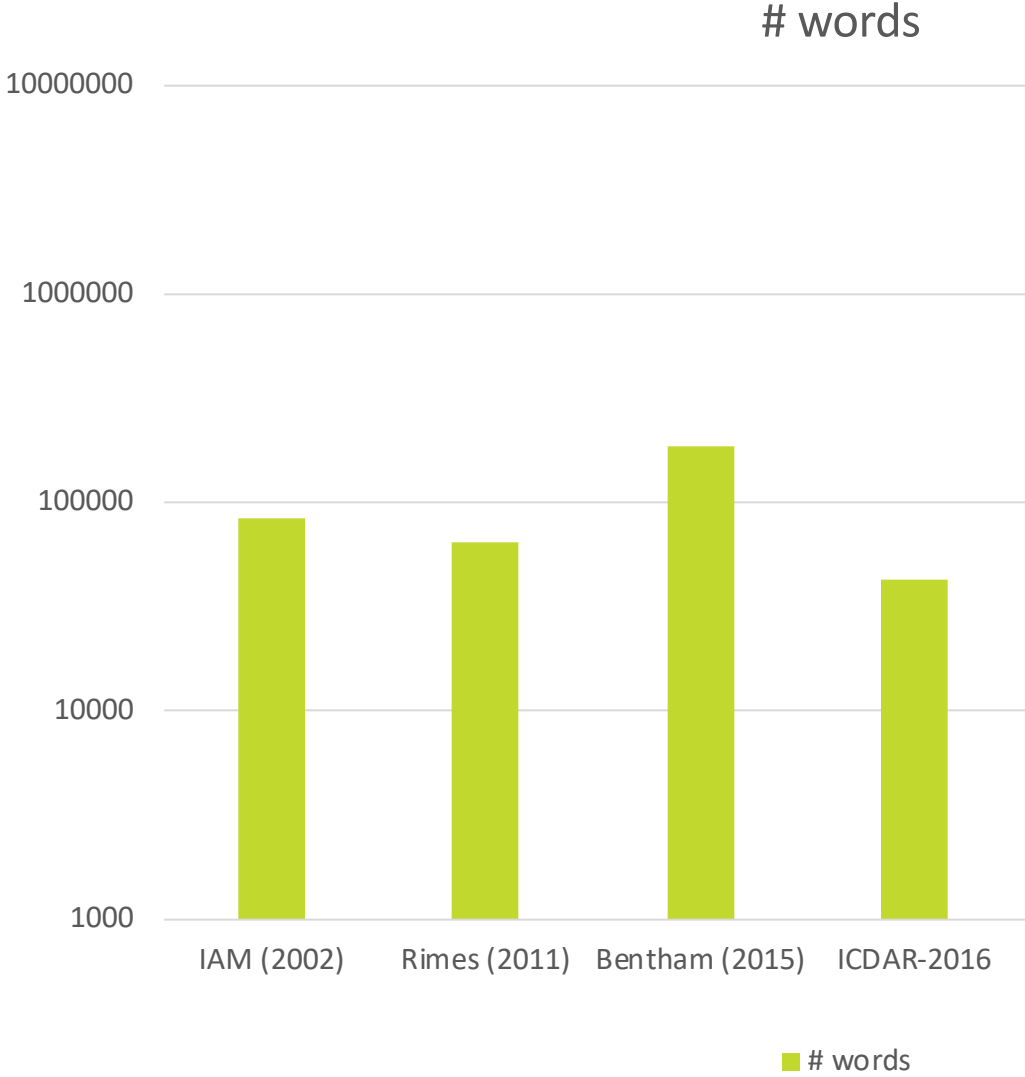

Combined Transcribed
Data from Digital Archives



Adobe